



HARDWARE

USER MANUAL

WWW.UNICORECOMM.COM

UM980eb

Evaluation Board

Copyright© 2009-2023, Unicore Communications, Inc.
Data subject to change without notice.

Revision History

| Version | Revision History | Date |
|---------|------------------|-----------|
| R1.0 | First release | Dec. 2023 |

Legal right notice

This manual provides information and details on the products of Unicore Communication, Inc. ("Unicore") referred to herein.

All rights, title and interest to this document and the information such as data, designs, layouts contained in this manual are fully reserved, including but not limited to the copyrights, patents, trademarks and other proprietary rights as relevant governing laws may grant, and such rights may evolve and be approved, registered or granted from the whole information aforesaid or any part(s) of it or any combination of those parts.

Unicore holds the trademarks of "和芯星通", "UNICORECOMM" and other trade name, trademark, icon, logo, brand name and/or service mark of Unicore products or their product serial referred to in this manual (collectively "Unicore Trademarks").

This manual or any part of it, shall not be deemed as, either expressly, implied, by estoppel or any other form, the granting or transferring of Unicore rights and/or interests (including but not limited to the aforementioned trademark rights), in whole or in part.

Disclaimer

The information contained in this manual is provided "as is" and is believed to be true and correct at the time of its publication or revision. This manual does not represent, and in any case, shall not be construed as a commitments or warranty on the part of Unicore with respect to the fitness for a particular purpose/use, the accuracy, reliability and correctness of the information contained herein.

Information, such as product specifications, descriptions, features and user guide in this manual, are subject to change by Unicore at any time without prior notice, which may not be completely consistent with such information of the specific product you purchase.

UM980eb User Manual

Should you purchase our product and encounter any inconsistency, please contact us or our local authorized distributor for the most up-to-date version of this manual along with any addenda or corrigenda.



Foreword

This manual provides information on the hardware composition and design of UM980eb (evaluation board).

Target Readers

This document is written for technicians who are familiar with GNSS modules.

Contents

| | | |
|----------|--------------------------------------|-----------|
| 1 | Product Overview | 1 |
| 2 | Interfaces | 4 |
| 3 | Power Supply | 6 |
| 3.1 | 3.3V LDO Power Supply | 7 |
| 3.2 | 5V DC/DC Power Supply | 8 |
| 3.3 | Backup Power Supply..... | 9 |
| 4 | Antenna Circuit | 10 |
| 4.1 | Antenna Detection Circuit | 10 |
| 4.2 | Antenna Feed Circuit | 12 |
| 5 | LED Indicators | 13 |
| 6 | UM980 Peripheral Design | 14 |
| 7 | Debug Support | 16 |
| | Appendix | 17 |

1 Product Overview

UM980eb is the evaluation board for UM980 and consists of the UM980 module, a 3.3V low dropout regulator (LDO), a 5V DC/DC boost circuit, an antenna detection circuit and peripheral interfaces.

☞ The schematic of the UM980eb can be used as the reference design for the UM980 module.

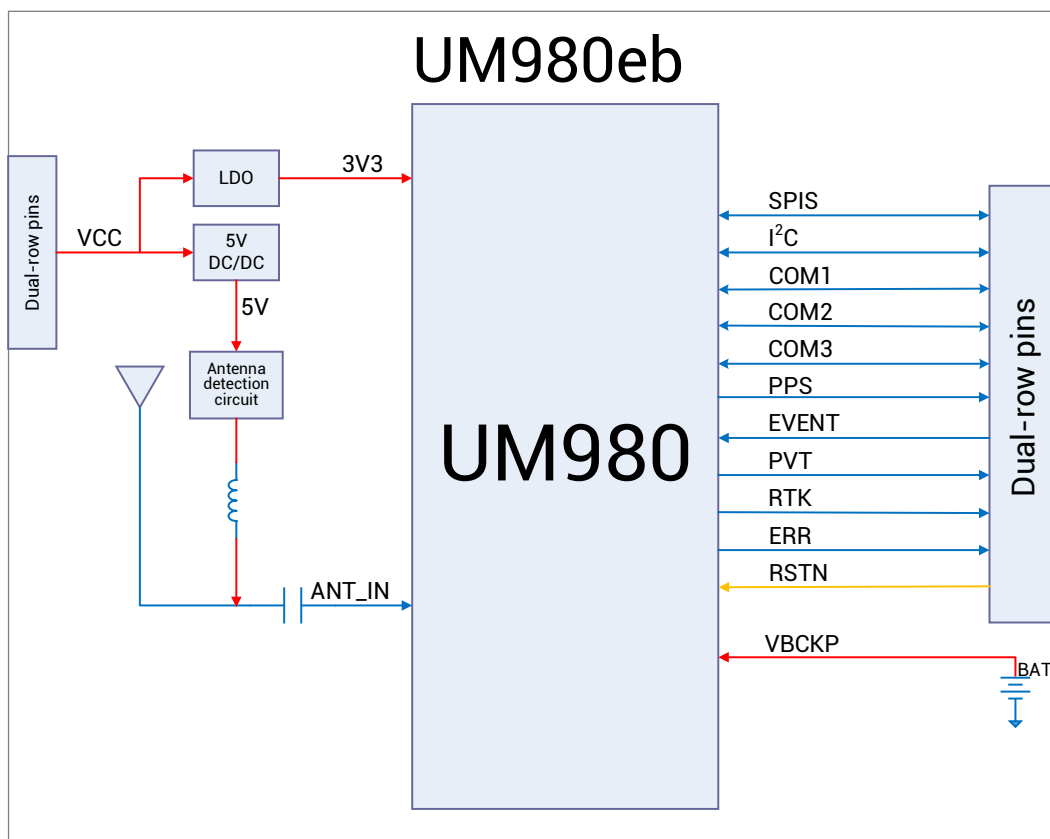

Figure 1-1 UM980eb Block Diagram

UM980eb User Manual

The appearance of UM980eb is shown as follows:

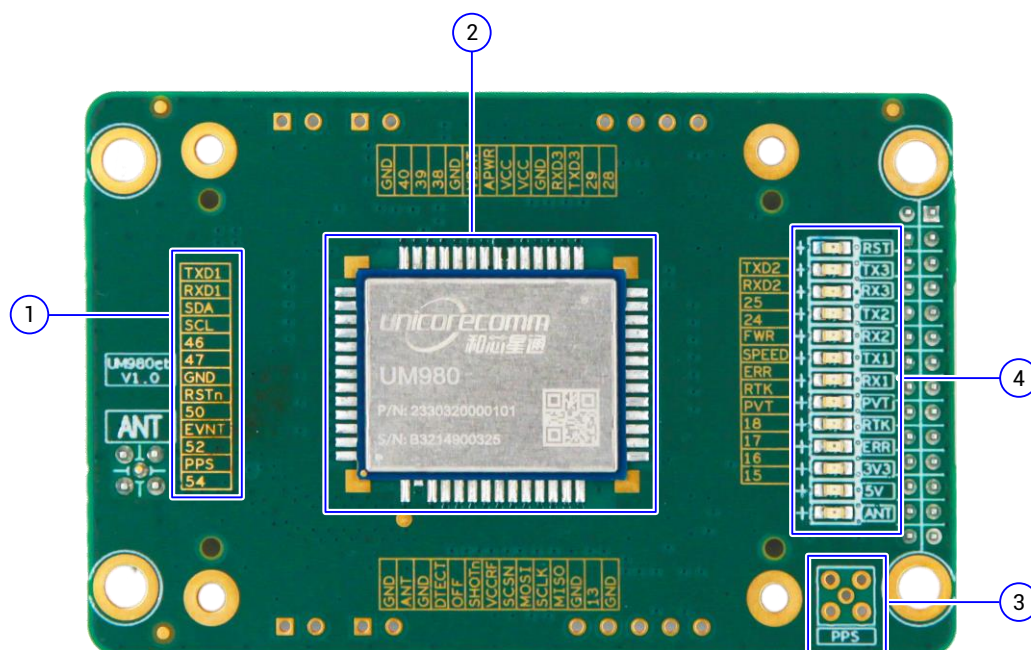

Figure 1-2 Top View of UM980eb

- (1) Silkscreen: It marks the signals of the pins. The smaller holes around are used to mount the UM980 socket. The printing adopts exposed copper to ensure the flatness of the surface.
- (2) UM980 module: The pin pads are designed long, which is convenient for soldering, testing and debugging. For detailed packaging information, please refer to the PCB document.
- (3) PPS connector: To measure the PPS signal, solder an MMCX connector here.
- (4) LED indicators: Indicating the status of the power supply, reset, antenna short circuit, the positioning status and UART.

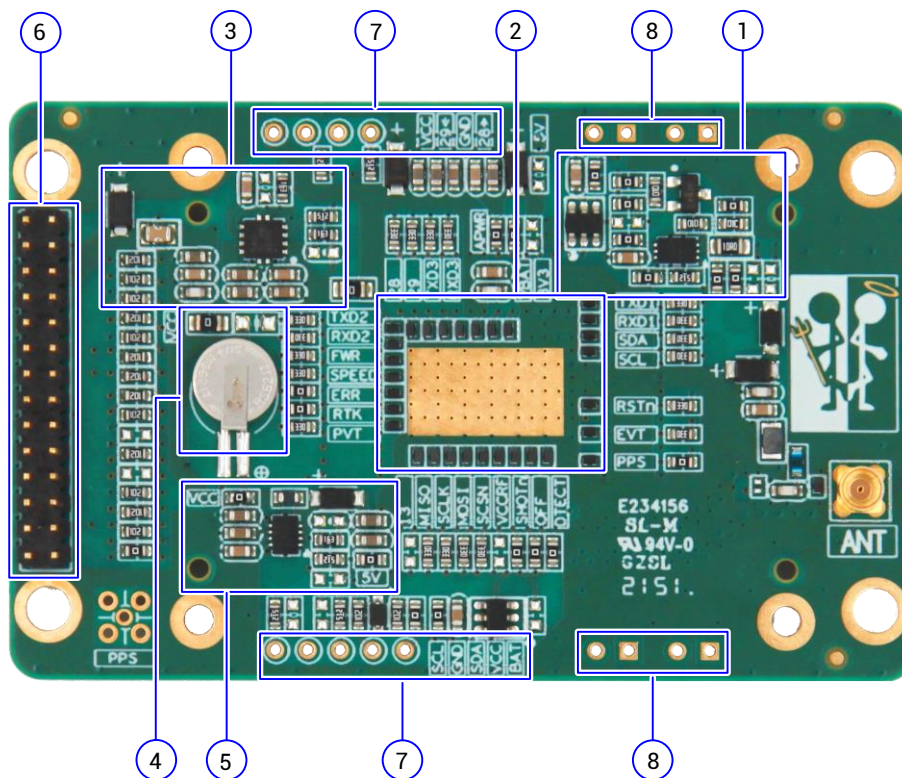

Figure 1-3 Bottom View of UM980eb

- (1) Antenna detection circuit
- (2) Anti-static design and heat dissipation with exposed copper
- (3) VCC power supply and LDO circuit
- (4) Backup battery
- (5) 5 V DC/DC boost circuit for antenna feeding
- (6) Dual-row pins as external interfaces
- (7) Debug ports
- (8) Ports used to connect jumpers

2 Interfaces

The dual-row 28 pins serve as the external interfaces of UM980eb, and the pin pitch is 2 mm. The interfaces can be directly connected to the J18 on Unicore HPL EVK-V5.0 board.

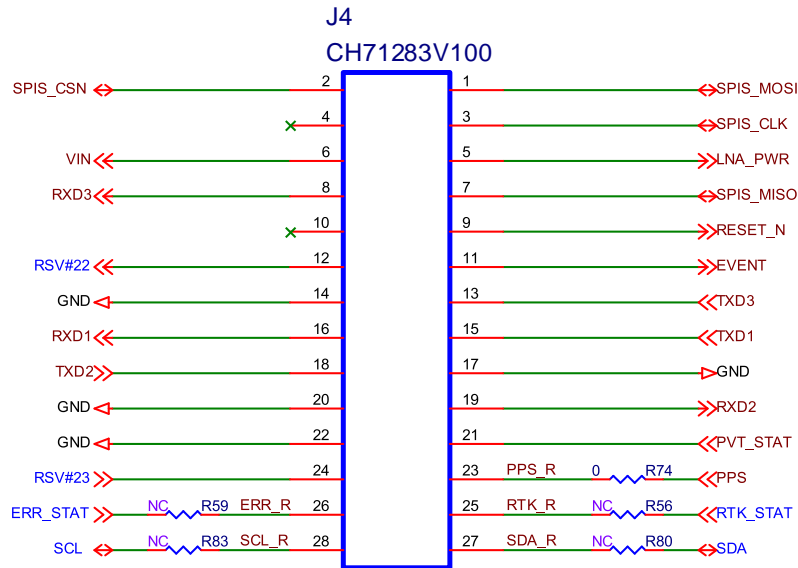

Figure 2-1 UM980eb Interfaces

Table 2-1 UM980eb Pin Description

| No. | Pin Name | I/O | Description |
|-----|-----------|-----|--|
| 1 | SPIS_MOSI | I | Master Out / Slave In. This pin is used to receive data in slave mode. |
| 2 | SPIS_CSN | I | Chip select pin for SPI slave |
| 3 | SPIS_CLK | I | Clock input pin for SPI slave |
| 4 | NC | — | No connection inside |
| 5 | LNA_PWR | I | Antenna feed voltage for LNA |
| 6 | VIN | I | Main power supply |

| No. | Pin Name | I/O | Description |
|-----|-----------|-----|---|
| 7 | SPIS_MISO | O | Master In / Slave Out. This pin is used to transmit data in slave mode. |
| 8 | RXD3 | I | COM3 input, can be used as CAN RXD, LVTTTL |
| 9 | RESET_N | I | System reset, active low. The active time should be no less than 5 ms. |
| 10 | NC | — | No connection inside |
| 11 | EVENT | I | Event input, with adjustable frequency and polarity |
| 12 | RSV#22 | — | Reserved |
| 13 | TXD3 | O | COM3 output, can be used as CAN TXD, LVTTTL |
| 14 | GND | — | Ground |
| 15 | TXD1 | O | COM1 output, LVTTTL |
| 16 | RXD1 | I | COM1 input, LVTTTL |
| 17 | GND | — | Ground |
| 18 | TXD2 | O | COM2 output, LVTTTL |
| 19 | RXD2 | I | COM2 input, LVTTTL |
| 20 | GND | — | Ground |
| 21 | PVT_STAT | O | PVT status, active high. High level when positioning and low level when not positioning. |
| 22 | GND | — | Ground |
| 23 | PPS | O | Pulse per second, with adjustable pulse width and polarity |

| No. | Pin Name | I/O | Description |
|-----|----------|-----|---|
| 24 | RSV#23 | — | Reserved |
| 25 | RTK_STAT | O | RTK status, active high. High level for RTK fixed solution and low level for other status. |
| 26 | ERR_STAT | O | Error status, active high. High level when failing self-test and low level when passing self-test. |
| 27 | SDA | I/O | I ² C data |
| 28 | SCL | I/O | I ² C clock |

 The availability of the ports depends on the firmware version of the UM980 module.

3 Power Supply

The power supply of the UM980eb is input from the VIN pin, passing through a circuit with surge protection and filter capacitors, to provide power for the 3.3 V LDO circuit and 5 V DC/DC boost circuit.

The input range of VIN is 3.2V to 5V.

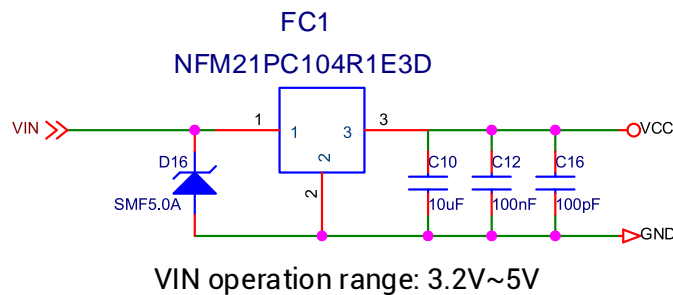

Figure 3-1 Power Filter Circuit

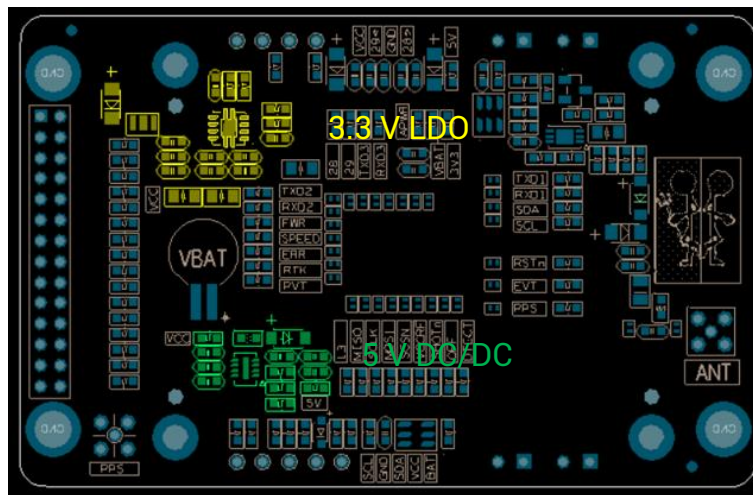

Figure 3-2 3.3 V LDO and 5 V DC/DC on the Bottom of UM980eb

3.1 3.3V LDO Power Supply

VCC outputs 3.3 V voltage after passing through the LDO circuit to provide power to UM980eb.

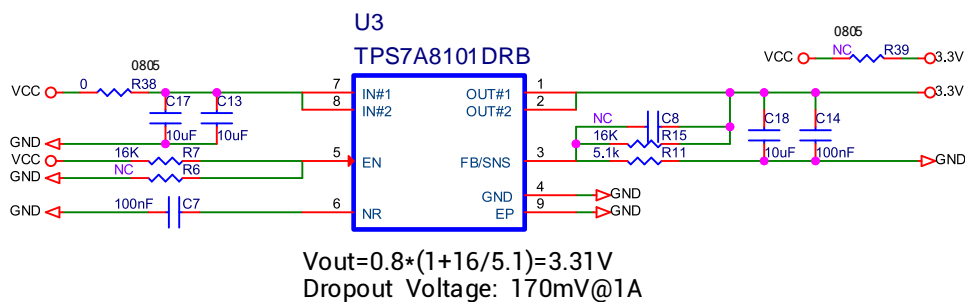

Figure 3-3 3.3V LDO Circuit

Notes:

- The rated output current of LDO should be more than twice the current of UM980.
- R38 is a series resistor placed at the input of the LDO, which is used for debugging. When selecting the resistor, choose one with high rated power to ensure the current capability. Here, a 0805 0-ohm resistor is selected.
- R39 is a resistor connected in parallel with LDO. After removing R38 and soldering R39, you can use VCC to power the module.

When using the LDO to power the module, you should consider the power dissipation of the LDO.

3.2 5V DC/DC Power Supply

VCC outputs 5 V voltage after passing through the DC/DC boost circuit to feed the antenna.

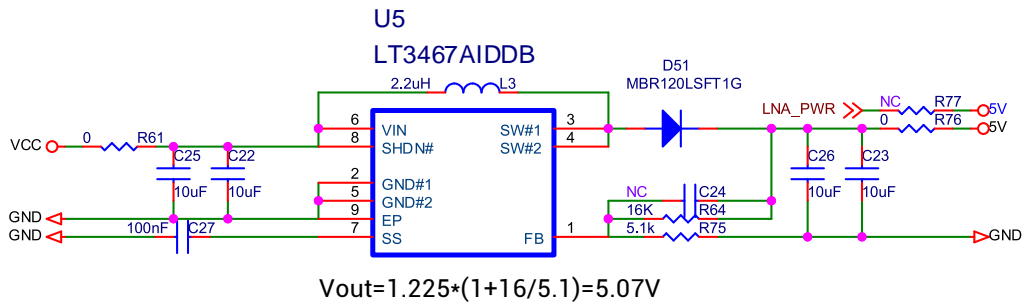

Figure 3-4 5V DC/DC Boost Circuit

Notes:

You can choose whether to use the 5 V power on the board to feed the antenna according to the antenna type.

R61 and R76 are series resistors connected to the DC/DC circuit at the input and output, which are used for debugging. When selecting the resistors, choose those with suitable rated power according to the power consumption of the antenna load. Here, a 0603 0-ohm resistor is selected.

R77: After removing R61/R76 and soldering R77, you can use the external LNA_PWR to feed the antenna.

3.3 Backup Power Supply

When using the hot start function of UM980, you need to provide backup power for the module.

The input range of V_BCKP is 2.0 V to 3.6 V.

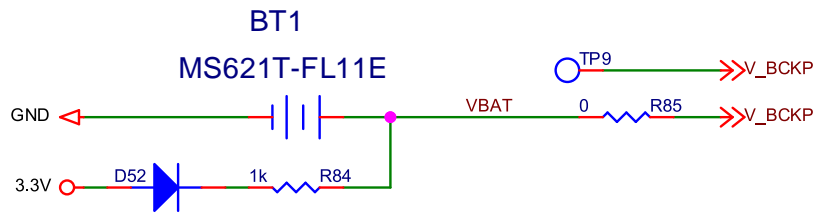

Figure 3-5 Backup Power Circuit

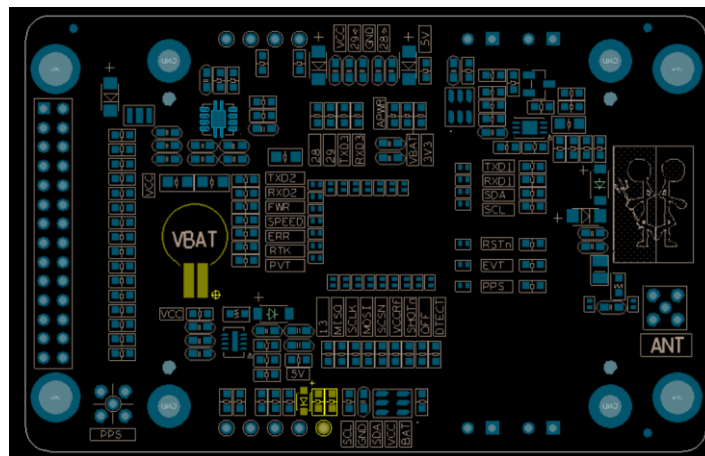

Figure 3-6 Backup Power Circuit on the Bottom of UM980eb



Notes:

When the backup battery supplies power to V_BCKP, the battery charging circuit should be designed to prevent reverse current to ensure that the battery only supplies power to V_BCKP and the current does not flow back into the 3.3 V power domain, as the D52 shows in Figure 3-5.

According to the maximum charging current of the battery, a current-limiting resistor should be added, as the R84 shows in Figure 3-5.

V_BCKP can also be powered through the test point TP9. Removing R85, connecting a power supply wire at TP9 and a ground wire at TP6, you can use an external power to supply V_BCKP. This method can be used to measure the supply voltage and current of

V_BCKP.

-  In the case of normal power supply to the evaluation board, the micro battery charging circuit on the board will automatically charge the micro battery.
 -  If the evaluation board has been placed for a long time, the power of the battery may be low and the hot start test may fail. Therefore, it is recommended to charge the board as long as possible before testing the hot start function.
 - 1) Use a multimeter to measure the voltage of the micro battery. If the voltage is above 2.6 V and is stable, it indicates that the power of the micro battery is sufficient.
 - 2) Use a multimeter to measure the voltage of the micro battery. If the voltage drops rapidly, it indicates that the power of the micro battery is insufficient.
 - 3) When the micro battery runs out of power, it will take more than 96 hours to fully charge the battery.
 - 4) Under normal circumstances, after powering the evaluation board for one night, the hot start test can be done normally the next day.
-

4 Antenna Circuit

4.1 Antenna Detection Circuit

The antenna detection circuit consists of a MOS switch, a current detection chip and two buffers.

The antenna feed supply can be selected from the 5 V DC/DC circuit output or VCC_RF (supplied by the module). VCC_RF provides 3.3 V voltage, but the circuit has less protective design; therefore, it is not recommended to use VCC_RF to supply power to the antenna.

U6 and U2 are two buffers with open-drain output. ANT_OFF1 needs to be pulled up through ANT_BIAS1 to make sure that MOS can be turned off.

The current threshold can be adjusted by changing the resistance value of R24/R13/R14. Since the feed current flowing through R24 will generate a voltage drop, this solution is not suitable for antennas with high power consumption.

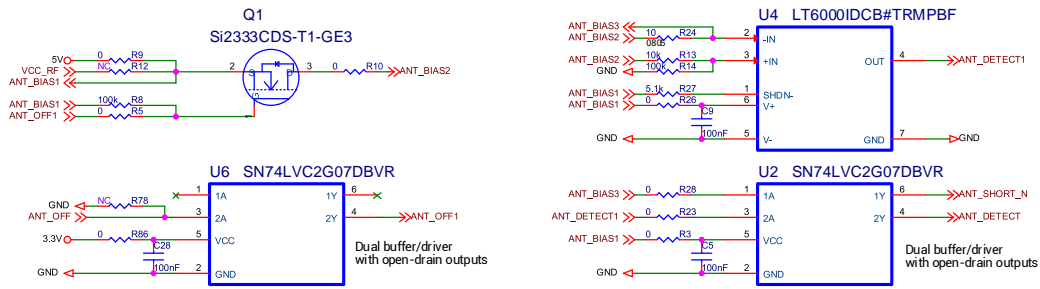

Figure 4-1 Antenna Detection Circuit

Table 4-1 Truth Table of the Antenna Detection Circuit

| ANT-OFF | ANT-DETECT | ANT-SHORT-N | |
|---------|------------|-------------|--|
| 1 | X | X | The antenna feed supply is turned off |
| 0 | 0 | 0 | An error occurred in the circuit |
| 0 | 0 | 1 | The antenna feed current < 50 mA; no antenna detected |
| 0 | 1 | 0 | The antenna feed circuit is shorted to ground |
| 0 | 1 | 1 | The antenna feed current > 50 mA; the antenna status is normal |

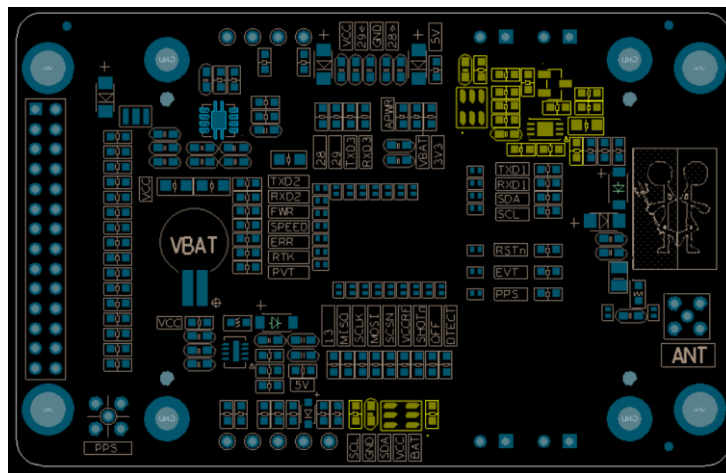

Figure 4-2 Antenna Detection Circuit on the Bottom of UM980eb

4.2 Antenna Feed Circuit

The antenna feed circuit consists of the anti-reverse current design, anti-surge design, filter inductors, and ESD protection.

The supply voltage can be selected from 5 V, VCC_RF or ANT_BIAS3 through R31/R29/R30. When using the 5 V voltage or VCC_RF, the antenna detection circuit on UM980eb will be bypassed.

The ESD protection diode should support high-frequency signal (above 2000 MHz). Nexperia PESD5V0F1BL is recommended here.

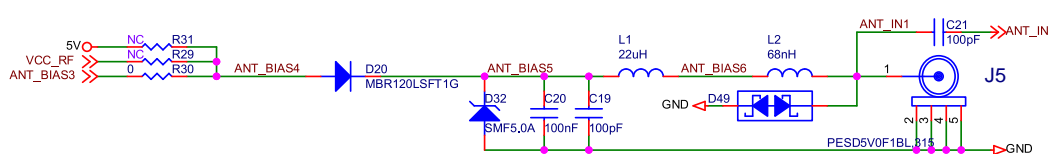

Figure 4-3 Antenna Feed Circuit

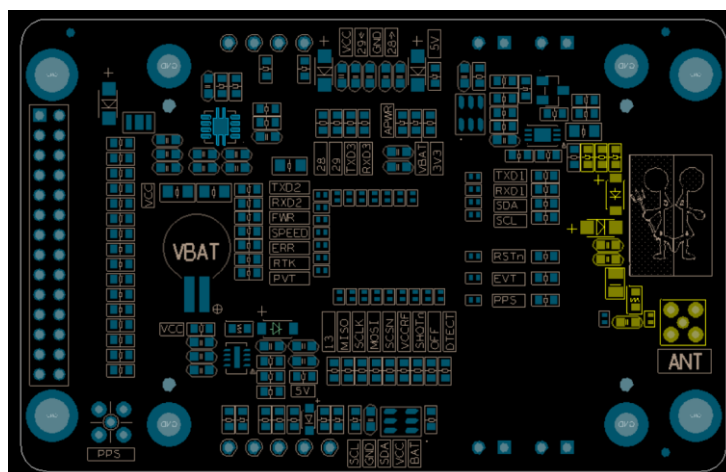

Figure 4-4 Antenna Feed Circuit on the Bottom of UM980eb

5 LED Indicators

There are LED indicators on UM980eb to indicate the working status of each functional unit.

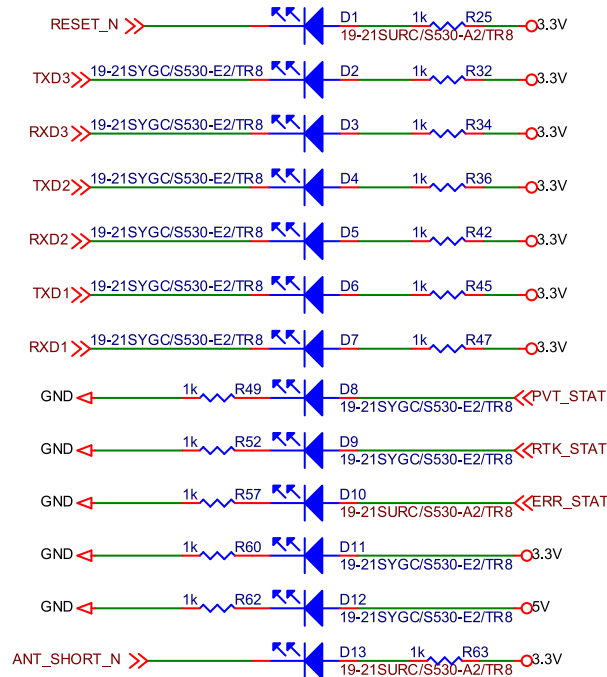

Figure 5-1 LED Indicators

Table 5-1 Description of the LED Status

| LED Indicator | Color | Description |
|--------------------|-------|---|
| Power (5V or 3.3V) | Green | Light on when the power is normal |
| Reset | Red | Light on when pressing the reset button |
| Antenna | Red | Light on when antenna is shorted |
| PVT | Green | Light on when position is fixed |
| RTK | Green | Light on when RTK is fixed |
| ERR | Red | Light on when failing self-test |
| UART | Green | Blinking when UART is working |

The silkscreen markings on the right of the LED indicators identify the corresponding functions, as shown in the figure below.

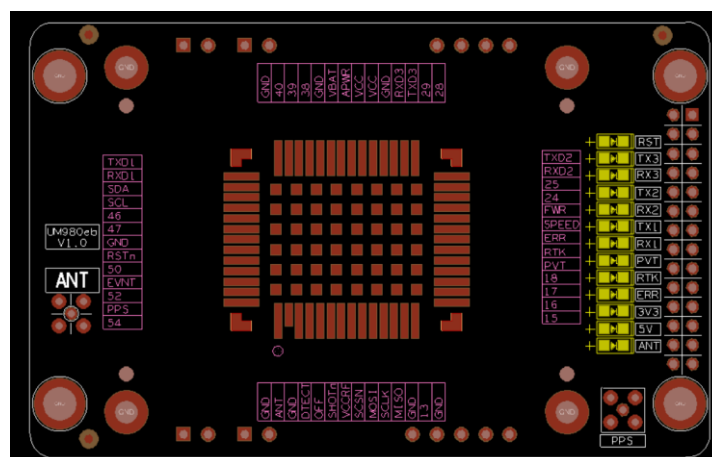

Figure 5-2 Markings on the Right of the LED Indicators

6 UM980 Peripheral Design

TVS anti-surge protection is added at the input of the UM980 module. ESD protection is added at all pins.

Use large and small VCC filter capacitors together, with a total capacitance greater than 30 uF.

Add series resistors at the IO pins for the convenience of debugging.

VCCIN powers the UM980 module only. R33 is a large-size resistor (with high rated power) to ensure the current capability. In the figure below, a 0805 resistor is used.

Removing R33, connecting a power supply wire at TP1 and a ground wire at TP3 (as shown in Figure 7-1), you can use an external power to supply the module. This method can be used to measure the input voltage and current of UM980.

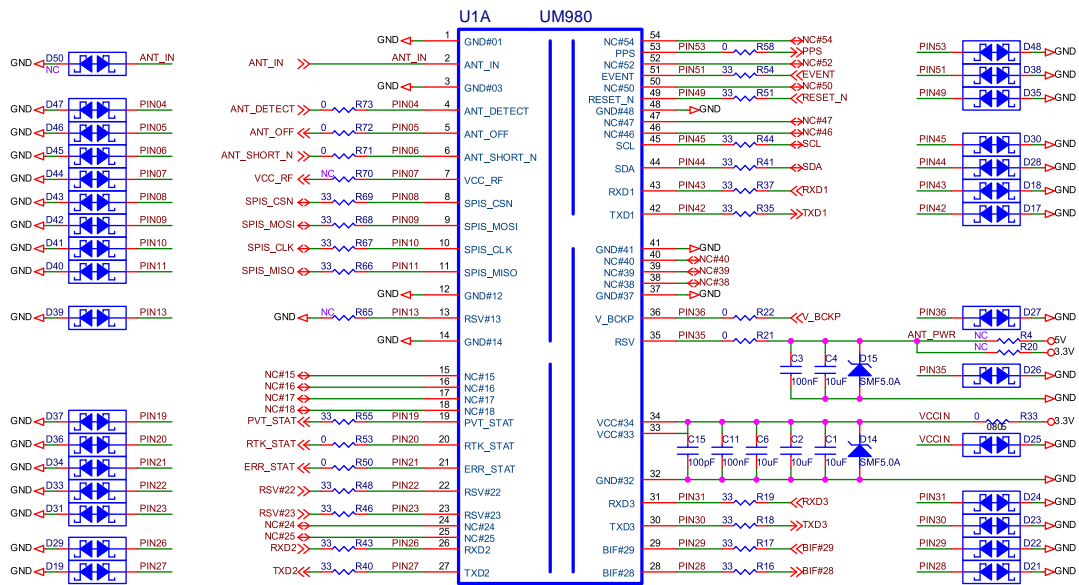

Figure 6-1 UM980 Peripheral Design

Silkscreen markings are printed around the UM980 module to identify the resistors, which is convenient for measurement.

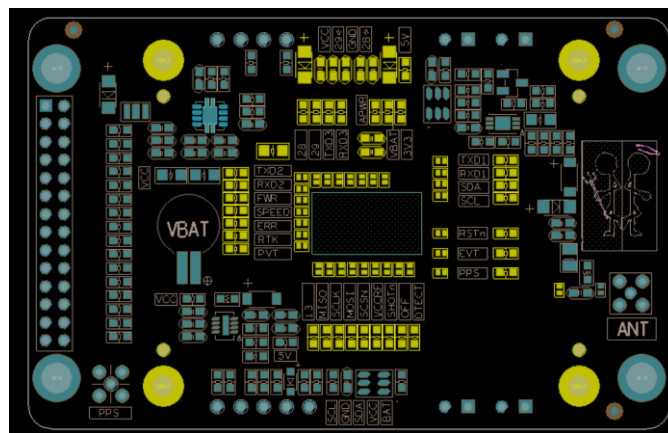

Figure 6-2 UM980 Peripheral Circuit

The GND pads at the bottom of the module should be grounded to ensure heat dissipation. The UM980eb has copper exposed on the bottom of the UM980 module, which not only enhances heat dissipation, but also provides a large area for grounding and is convenient to test.

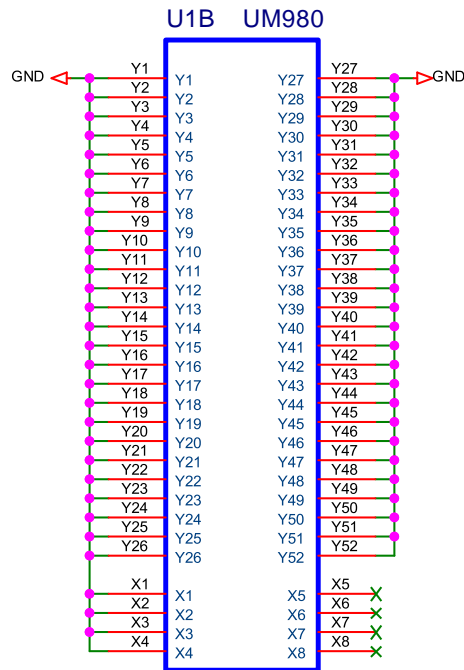

Figure 6-3 UM980 Pads (Y1-Y52) and Socket Mounting Holes (X1-X8)

7 Debug Support

As mentioned above, TP1 and TP9 can be used to connect an external power to supply VCCIN and V_BCKP and to measure the supply voltage and current.

TP2, TP3, TP5 and TP7 are used for internal debugging, of which TP5 and TP7 can be used to debug I²C.

J1 is used for MMCX connection. After soldering the MMCX connector, it can be used to measure the PPS signals.

J2, J3, J6 and J7 are debug ports. Connect the signal that needs to be tested to the square hole and test the round hole, or connect the round hole to a measuring instrument. Using these debug ports can avoid damage to the PCB pads and traces, which is convenient for debugging.

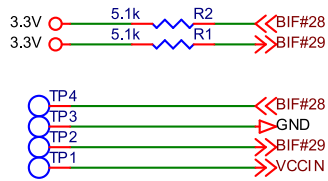

Debug1

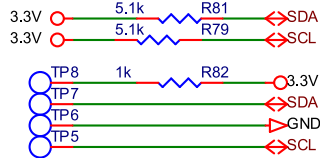
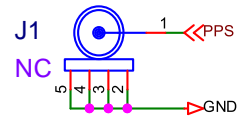

Debug2

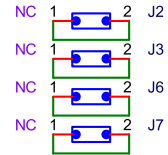

Debug3

Figure 7-1 Debug Ports for the UM980 Module

The silkscreen markings on the right of the test points are arranged in order to identify the function of each port.

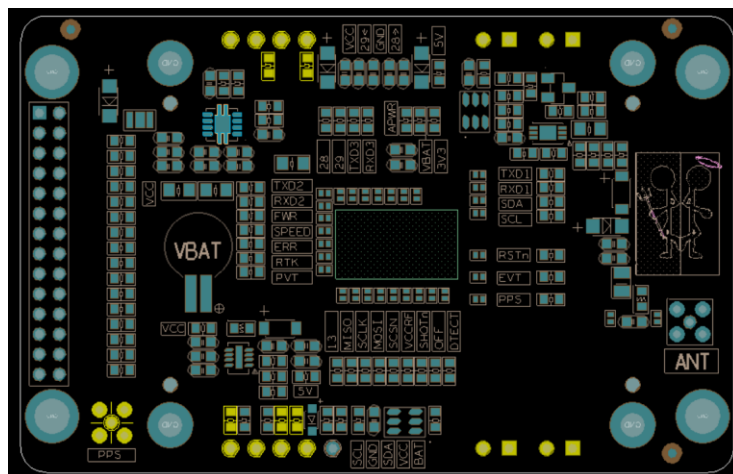
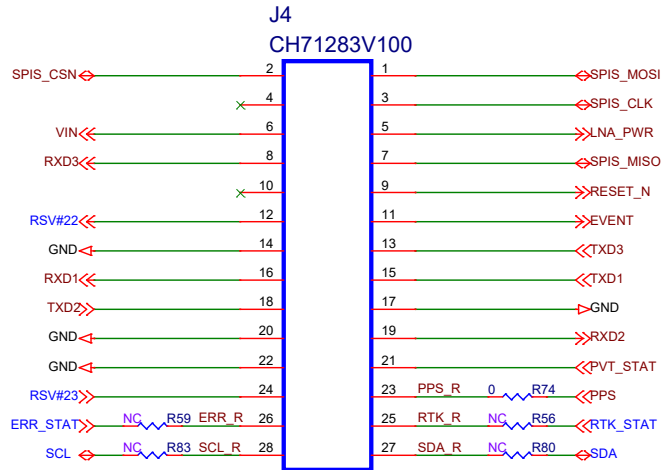

Figure 7-2 Through-Hole Test Points on UM980eb

Appendix

Schematic of UM980eb



Interface

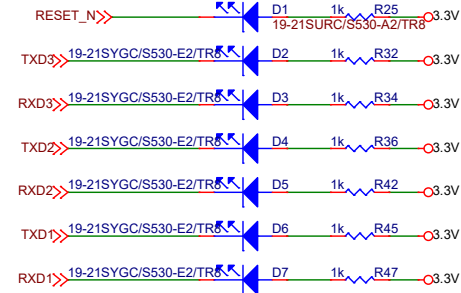

LEDs

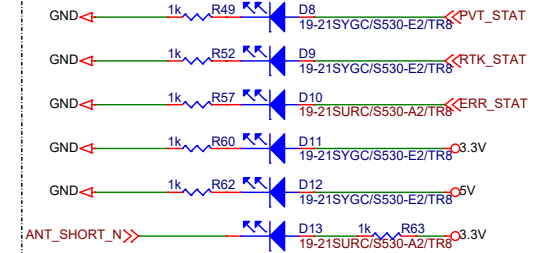

LEDs

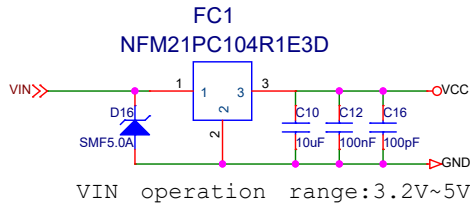

Power Filter

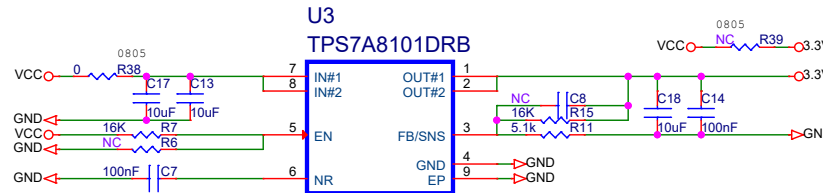

LDO 3.3V

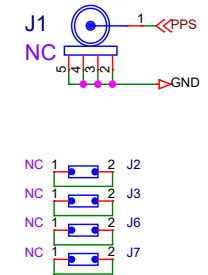

Debug3

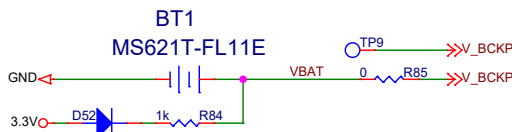

V_BCKP

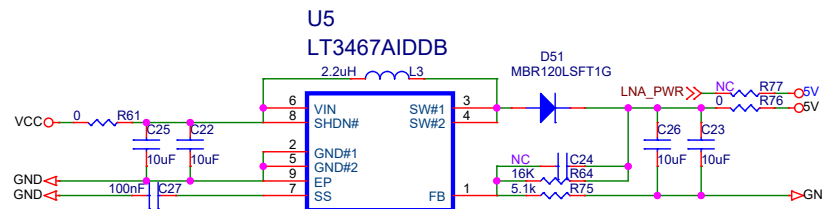

DC/DC 5V

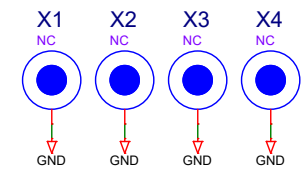

Hole

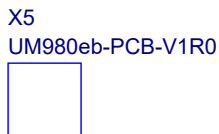

Unicore Communications, Inc

| | | | |
|-------|--------------------------|----------------------|--------|
| Title | | UM980eb | |
| Size | Document Number | Interface Power LEDs | |
| B | | | |
| Date: | Friday, January 21, 2022 | Sheet | 3 of 5 |
| | | 1 | |

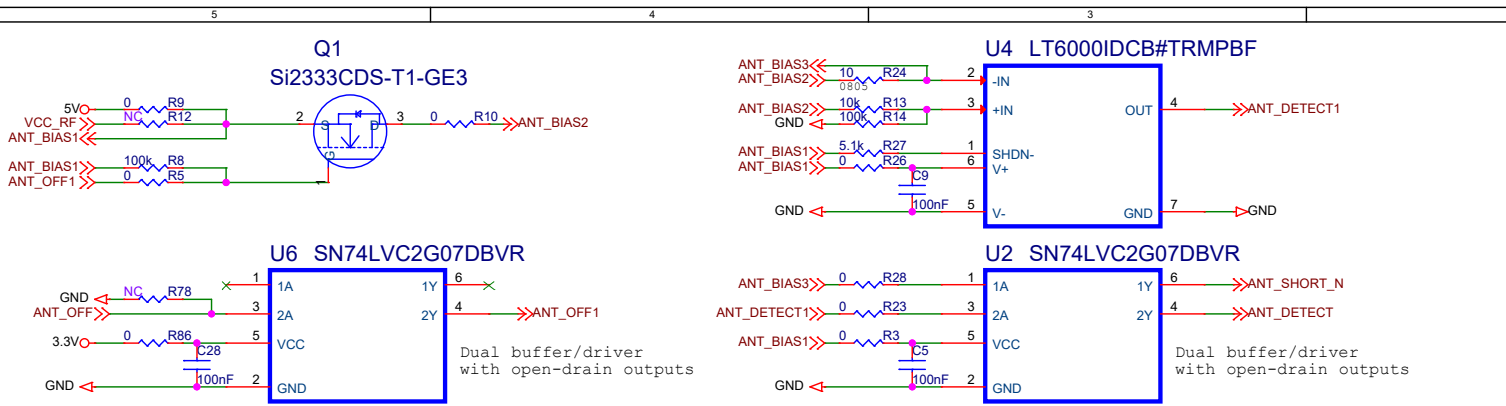

| ANT-OFF | ANT-DETECT | ANT-SHORT-N | |
|---------|------------|-------------|-------------------------|
| 1 | X | X | Ant-Bias Turn off |
| 0 | 0 | 0 | Circuits Maybe error |
| 0 | 0 | 1 | Ant-Bias Current < 50mA |
| 0 | 1 | 0 | Ant-Bias Short to GND |
| 0 | 1 | 1 | Ant-Bias Current > 50mA |

Ant Bias Status Detect

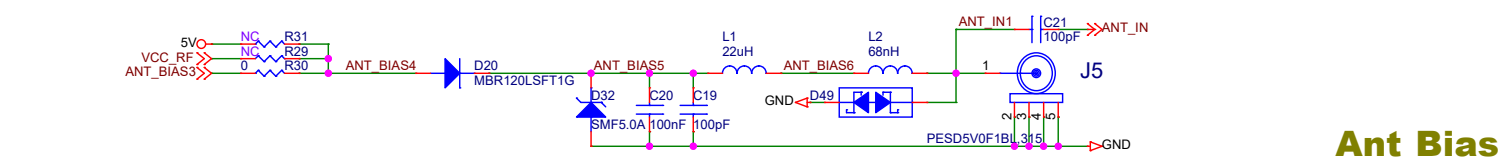

Ant Bias

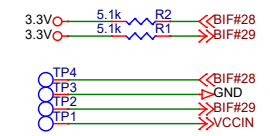

Debug1

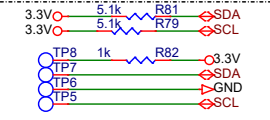

Debug2

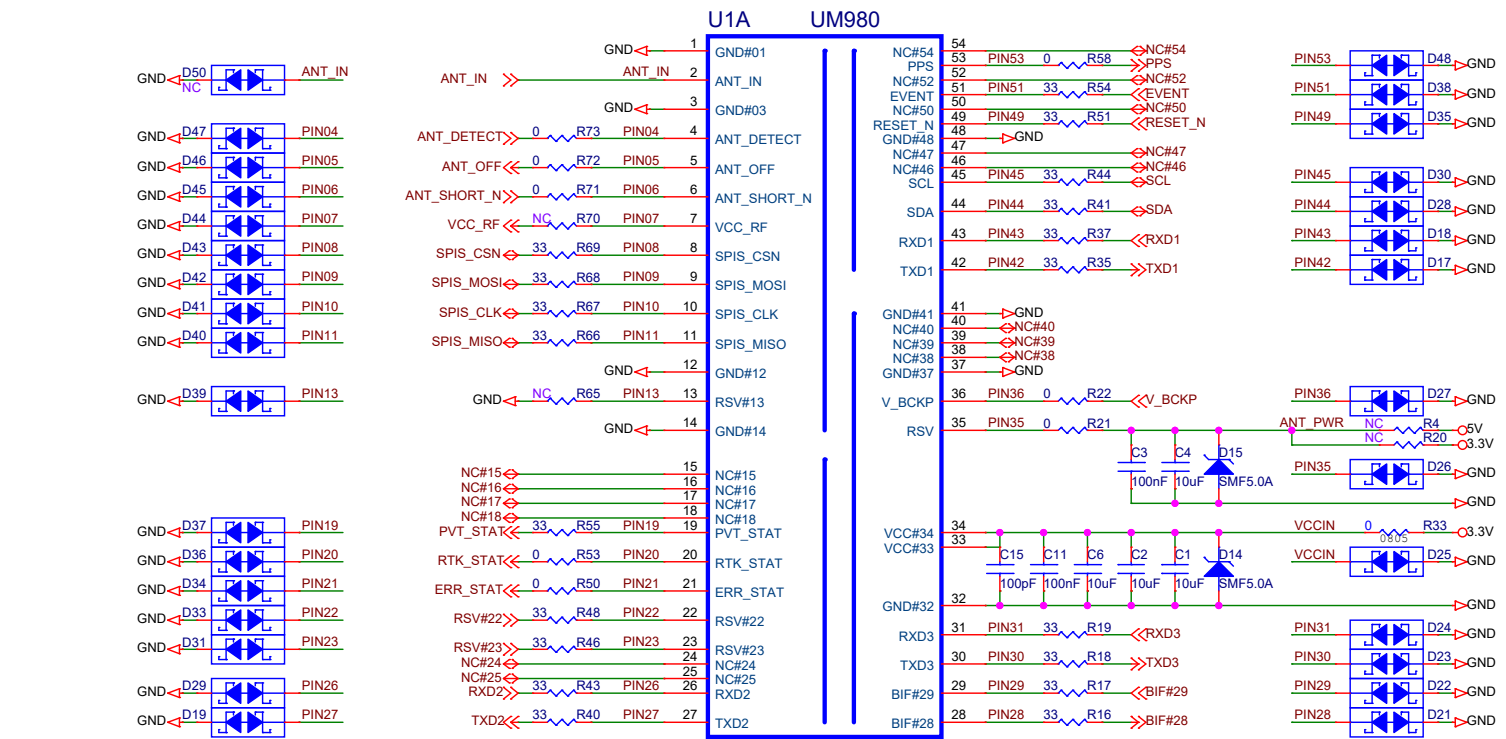
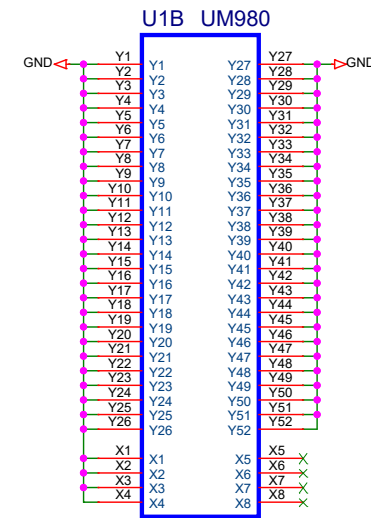

UM980 Module

Unicore Communications, Inc

Title: **UM980eb**

Size: B Document Number: UM980 Module, Ant Bias, Debug Interface Rev: V1.0

Date: Friday, January 21, 2022 Sheet: 4 of 5

Assembly Top of UM980eb

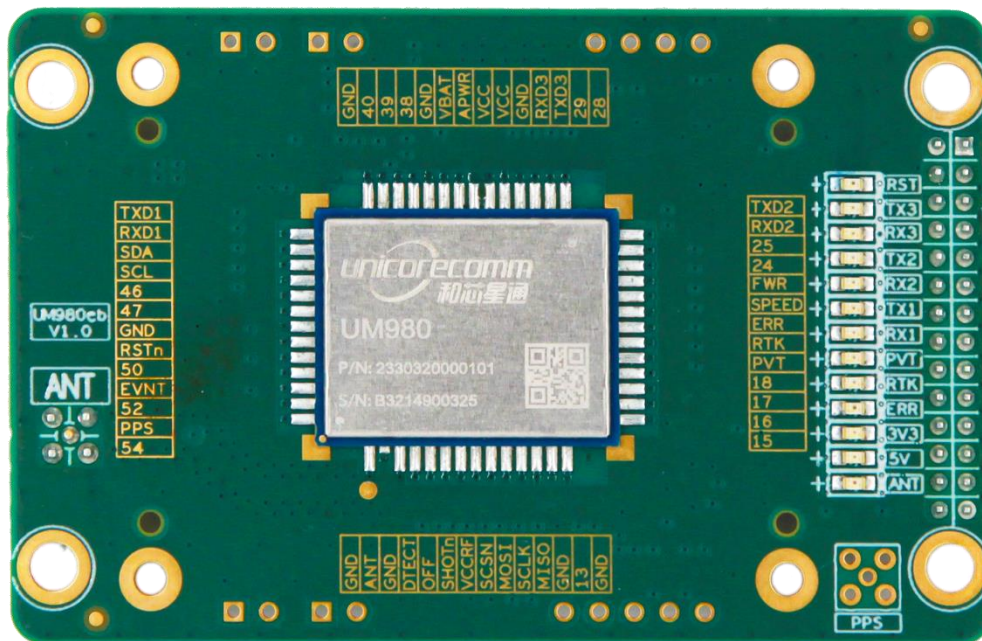
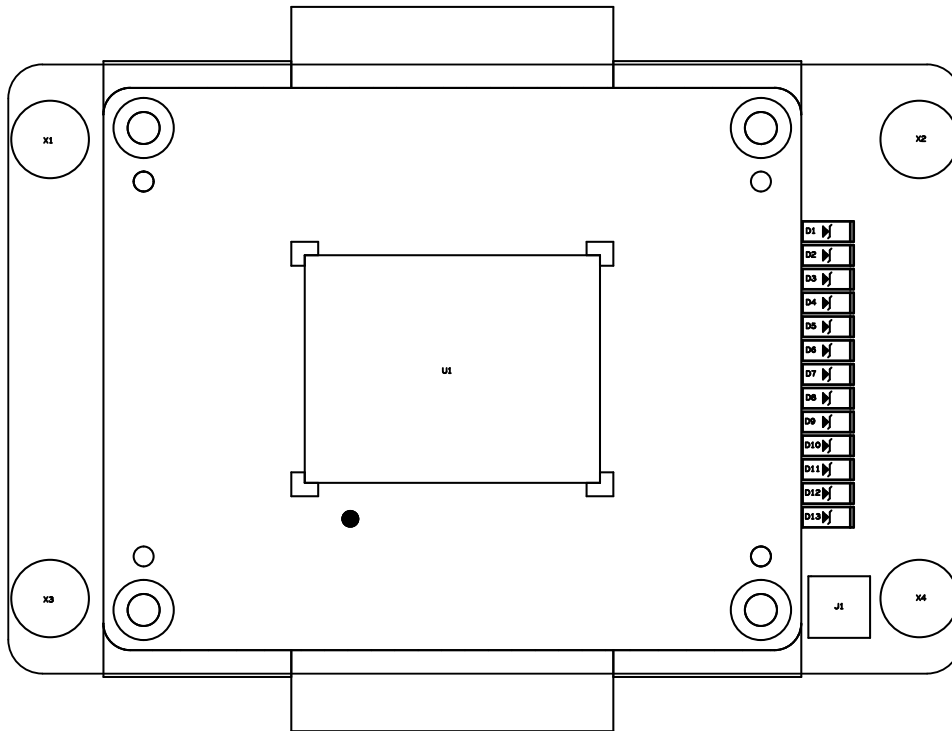

Assembly Bottom of UM980eb

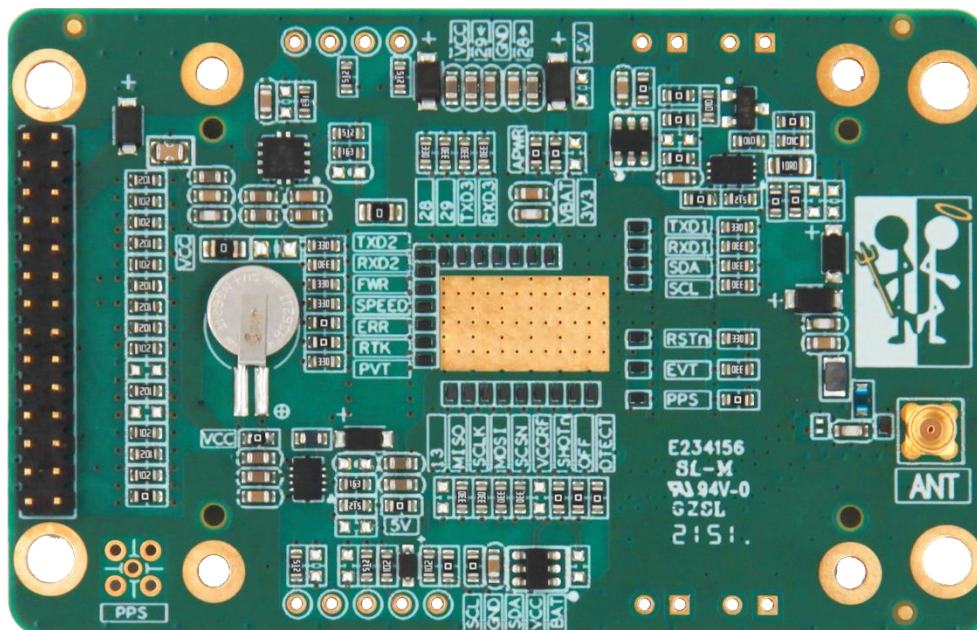
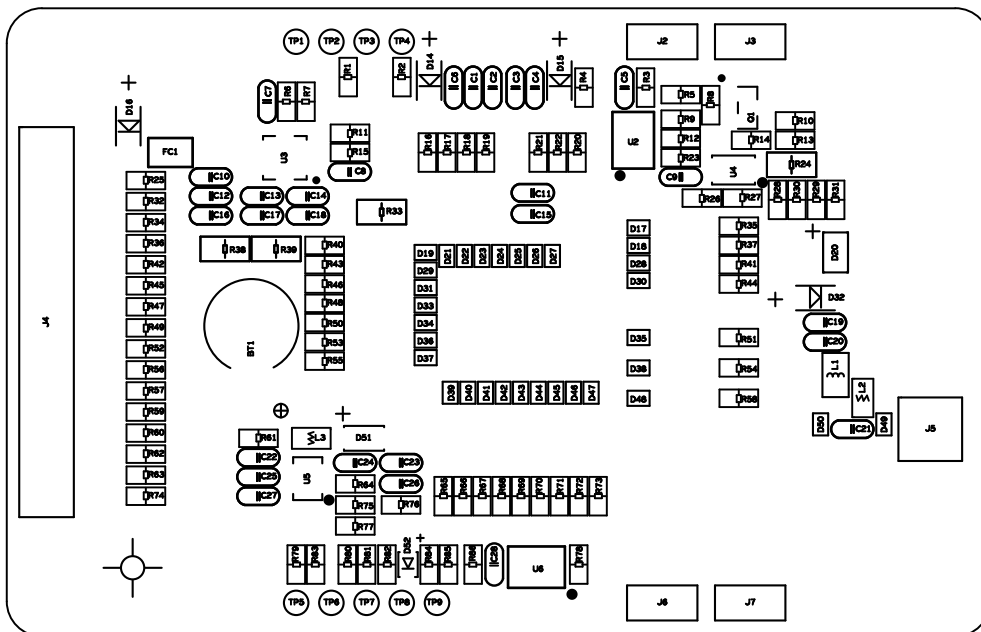

和芯星通科技（北京）有限公司
Unicore Communications, Inc.

北京市海淀区丰贤东路 7 号北斗星通大厦三层
F3, No.7, Fengxian East Road, Haidian, Beijing, P.R.China,
100094

www.unicorecomm.com

Phone: 86-10-69939800

Fax: 86-10-69939888

info@unicorecomm.com



www.unicorecomm.com